



The New Mercedes-Benz eVito.

Electric Panel Van model.

Prices effective from March 2022.

Mercedes-Benz





RETURN TO START



Contents

> Summary	3
> Standard equipment highlights	4
The New eVito PROGRESSIVE	5
The New eVito PREMIUM	6
> List price summary	7
> eReady finance	8
> Driver Assistance Package	9
> Equipment overview	10
> Colours and upholstery	13
> Charging information	14
> Technical data	15
> Mercedes-Benz Vans and the environment	19
> EQ Ready app	20
> Approved used	21
> Service 24: Demand more	22



Please note

This document provides information about the model range line-up and specifications of the eVito. It also contains key details about options, economy and performance of all variants. Details are correct at time of publication and are subject to revision without notice. Any images used in this document may not reflect UK specification and are for illustrative purposes only. Images may show optional equipment which does not form part of UK standard specification. Pricing in this price list applies to 66kWh models only.

The New eVito Summary.



RETURN TO START

1 vehicle model:	Panel van with 3 seats
1 charging configuration:	AC: 11kW with DC: 80kW**
2 vehicle lengths:	L2 or L3
2 trim levels:	PROGRESSIVE or PREMIUM
2 speed limit options:	75 mph (120 Km/h) – (Standard) 50 mph (80 Km/h) – (Optional)

All-electric WLTP combined range, full charge
160 – 162 miles

80% charge top-up in just
35 minutes

Class-leading
Safety and Connectivity



L2: 5,140mm



L3: 5,370mm

Height: 1,910mm



CCS rapid charging port, 80kW max. capacity.



Crosswind Assist and Active Brake Assist.



Audio 30 touchscreen and Mercedes me services as standard.

Electrical WLTP range for the eVito 66kWh Panel Van range in miles (km): 160 (258) – 162 (260). Electrical consumption in kWh/100 km: 25.7 – 25.9. Combined CO₂ emissions in g/km: 0.

Figures correct as of December 2021. The indicated values were determined according to the prescribed measurement method - Worldwide Harmonised Light Vehicle Test Procedure (WLTP). Battery Electric Vehicles (BEV) require mains electricity for charging, range figures determined with the battery fully charged. Figures shown are for comparability purposes; only compare with other cars tested to the same technical procedure (WLTP). Figures may not reflect real life driving results, which will depend upon a number of factors including the starting charge of the battery, factory-fitted options, accessories fitted (post registration), variations in weather, driving styles and vehicle load. Further information about the test used to establish range, power consumption and CO₂ figures can be found at <http://www.mercedes-benz.co.uk/WLTP>. For real time data visit https://voc.mercedes-benz.com/voc/gb_en. **Charging times are subject to the power available at the location where the vehicle will be charged as well as external factors such as temperature and type of cable and charger used.

Standard Equipment Highlights. All models.



RETURN TO START

All our eVito models combine the very best of safety, efficiency and connectivity. All our eVito models include:

Active Brake Assist with pedestrian and cyclist detection. The system helps to prevent rear-end collisions. Active Brake Assist can help you to prevent accidents (with vehicles driving in front, with crossing pedestrians or cyclists) or to minimise their consequences.

Attention Assist drowsiness detection. Can help to avoid momentary nodding off and therefore provides you with increased safety, in particular when driving at night and on long journeys. The system provides you with a visual and audible warning if it identifies typical signs of fatigue or attention lapses, and suggests taking a break.

Acoustic Presence Indicator All our electric vehicles come as standard with an external acoustic warning to alert pedestrians or cyclists at speeds under 19 mph.

Crosswind Assist detects strong crosswinds and helps the driver to remain in their lane by autonomous targeted braking intervention.

Audio 30 infotainment system with 7-inch touchscreen, DAB radio, Bluetooth®, Apple CarPlay and Android Auto. The system includes two USB interfaces.

Anti-theft Protection Package helps to secure the vehicle by triggering a visual and an acoustic alarm if it detects a danger of theft. It consists of an anti-theft alarm system (ATA), interior protection, tow-away protection and a double-lock system.

DYNAMIC SELECT allows the driver to switch between driving modes: comfort [C], efficiency [E] and efficiency plus [E+]. They program the strategies for heating, ventilation, drivetrain and ancillaries; allowing maximum comfort or maximum range.

Reverse Camera the camera assists when parking and manoeuvring: it displays the area behind the vehicle. Damage can be avoided and pedestrians spotted more easily. Dynamic guidelines and a 180° view also facilitate orientation when reversing.

Heated driver's seat ensures comfort in cold conditions. The seat heating can be a more efficient way of heating the driver, in particular, when getting in-and-out of the vehicle frequently. In addition, it uses less energy than the vehicle heater.

Energy-saving mode for climate control an automatic control can moderate the heating system in some circumstances to save energy. For example, if the driver frequently opens the door or windows. It is not active in comfort mode.

Mercedes me services Assist the driver with pre-conditioning, finding a charge point and much more.

Emergency Call System can ensure crucial time savings in an emergency. Using a communication module with its own SIM card, an automatic emergency call is initiated following an accident, thereby potentially reducing the time before the emergency services arrive at the scene. GPS information can be sent if the driver is unresponsive. The emergency call can also be initiated manually in order to request help.

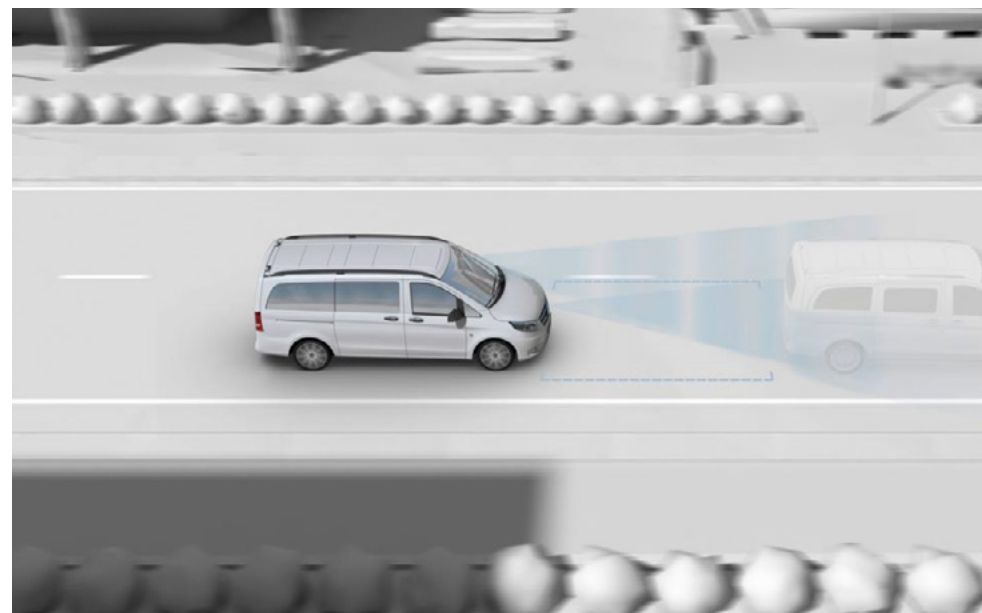

Illustration of Active Brake Assist.



RETURN TO START

The New eVito 66kWh PROGRESSIVE model.

Standard features for the eVito 66kWh PROGRESSIVE include:

Exterior

- Black-grain bumpers, front and rear
- 17-inch steel wheels with centre cover
- Electrical steering
- Halogen headlights and tail-lights
- Daytime running lights
- Adaptive brake lights
- Pre-installation for roof loading systems
- Towing points, front and rear
- Heated and electrically adjustable door mirrors
- Summer tyres
- Rolling resistance optimised braking system
- Suspension setting for goods vehicles

Interior

- Audio 30 with DAB radio, Apple CarPlay and Android Auto smartphone integration
- Twin co-driver seat
- Energy-Saving mode for climate control
- Air conditioning, semi-automatic TEMPATIC
- Heated driver's seat
- Comfort driver's seat
- Adjustable steering wheel, reach and rake
- Multi-function steering wheel
- Comfort over-head control panel

Load area

- Rear 'barn' style doors, 180° opening
- Twin side loading doors
- 6 tie-down points in floor
- Full-height steel bulkhead
- TPO plastic flooring
- Side panelling in load area
- Weldnuts in sidewall for conversions

Technology, Safety and Driver Assistance Systems

- 66kWh lithium-ion battery
- Pre-install Mercedes me Standard Services
- Airbags, driver and co-driver
- Pre-install Mercedes me Navigation Services Plus
- AC Type 2 charging, max. 11kW
- Electrical strip for electrical consumables
- DC CCS charging, max. 80kW
- Reverse camera
- Active Brake Assist with pedestrian detection
- Headlight Assistant
- ATTENTION ASSIST drowsiness detection
- Anti-theft Protection Package with double-locks
- Cruise Control and hill start assist
- Tyre pressure monitoring
- Adaptive speed limitation function
- Emergency call system



Image shown includes optional front fog lights (L16).

Government OZEV grant of up to £5,000

The eVito is eligible for a Government OZEV grant that gives businesses 35% off the purchase price, up to a maximum of £5,000*.



Basic recommended list price (ex.VAT) for the eVito 66kWh L2 PROGRESSIVE

£43,600

Add £530 to upgrade to the L3 model

Add £3,300 to upgrade to the PREMIUM mode

▶ Arrange a test drive at your nearest Dealership

* Vehicle purchase price is calculated on base vehicle only (excluding any optional equipment), it excludes delivery charges and first registration fee. The grant will be applied after any vehicle discount has been offered and includes VAT and number plate costs. For more information, visit: <https://www.gov.uk/plug-in-car-van-grants>



RETURN TO START

The New eVito 66kWh PREMIUM model.

Standard features in addition/replacement to the eVito 66kWh PROGRESSIVE:

- **Exterior**
 - Painted bumpers
 - 17-inch light-alloy wheels, aerodynamically optimised
 - Metallic paint
 - Electrically folding exterior mirrors
 - Chrome grille
 - Adaptive brake lights
- **Interior**
 - Lumbar support for driver's seat, 4-way
 - Leather steering wheel
- **Technology, Safety and Driver Assistance Systems**
 - PARKTRONIC parking sensors, front and rear
 - Front fog lights



Government OZEV grant of up to £5,000

The eVito is eligible for a Government OZEV grant that gives businesses 35% off the purchase price, up to a maximum of £5,000*.



Basic recommended list price (ex.VAT) for the eVito 66kWh L2 PREMIUM

£46,900

▶ **Arrange a test drive at your nearest Dealership**

* Vehicle purchase price is calculated on base vehicle only (excluding any optional equipment), it excludes delivery charges and first registration fee. The grant will be applied after any vehicle discount has been offered and includes VAT and number plate costs. For more information, visit: <https://www.gov.uk/plug-in-car-van-grants>

List Price Summary.



RETURN TO START

Vehicle Model Description	Powertrain	CO ₂ emissions, WLTP	Basic Recommended Retail Price (Ex. VAT)	Total Recommended Retail Price (Inc. VAT)
eVito 66kWh Van L2 PROGRESSIVE	Battery electric vehicle, 114hp/85kW, FWD, single-speed automatic transmission Electric range 162 miles WLTP combined	0g/km	£43,600.00	£52,320.00
eVito 66kWh Van L3 PROGRESSIVE	Battery electric vehicle, 114hp/85kW, FWD, single-speed automatic transmission Electric range 160 miles WLTP combined	0g/km	£44,130.00	£52,956.00
eVito 66kWh Van L2 PREMIUM	Battery electric vehicle, 114hp/85kW, FWD, single-speed automatic transmission Electric range 162 miles WLTP combined	0g/km	£46,900.00	£56,280.00

Government OZEV grant of up to £5,000

The eVito is eligible for a Government OZEV grant that gives businesses 35% off the purchase price, up to a maximum of £5,000*.



Carbon Neutral Production

All Mercedes-Benz Vans and Cars, including the eVito, will benefit from carbon-neutral production starting from January 2022.

* Vehicle purchase price is calculated on base vehicle only (excluding any optional equipment), it excludes delivery charges and first registration fee. The grant will be applied after any vehicle discount has been offered and includes VAT and number plate costs. For more information, visit: <https://www.gov.uk/plug-in-car-van-grants>

This document is for guidance only and must be used in conjunction with a configuration tool prior to final specification decisions and vehicle quotations being prepared and accepted. List prices are quoted ex-factory unless otherwise stated. Delivery charges excluding VAT will be added to model prices quoted in this document. Prices based on standard finish paint choice. Mercedes-Benz Vans UK and authorised Dealers reserve the right to alter specification and vary prices without notice. The availability of options may depend on the chosen base vehicle and other optional equipment specified, and should be confirmed with your Mercedes-Benz Vans Dealer prior to order placement. VAT is calculated at the standard rate of 20%. Mercedes-Benz Vans UK Ltd, Tongwell, Milton Keynes MK15 8BA.

eReady finance – the flexible way to purchase your electric van.

If you're interested in an electric van but the idea of a lengthy finance agreement puts you off, our flexible eReady finance terms start from as little as 12 months. This allows you to make the switch with a level of commitment you feel comfortable with, and with a wide range of options at the end.

- Contract Hire deals available from 12 months
- Love your electric van? You can purchase it at the end of the agreement
- Want to explore your options? Regularly review your finance and vehicle options, then return or part-exchange the van at the end of your contract
- Switch to another electric van in the Mercedes-Benz range when new models become available.

› [Learn more about our finance options](#)

or if you'd prefer to talk to a Dealer, find the nearest one to you:

› [Find your preferred Dealer](#)

Latest eVito Panel Van offer

Based on an eVito Van L2 PROGRESSIVE 66kW*



RETURN TO START



Finance Monthly Rental	£420.00
Advance Rental	£2,520.00
Excess Mileage Charge ex. VAT	20 pence per mile

* BUSINESS USERS ONLY.

- 3 year lease on Contract Hire.
- Rentals exclude VAT.
- Offer ends 31/03/2022.
- Participating Dealers.
- Conditions apply.
- Mercedes-Benz Finance. MK15 8BA.

Prices are correct at time of going to press 01/2022. All prices are subject to any fiscal or legislative changes.

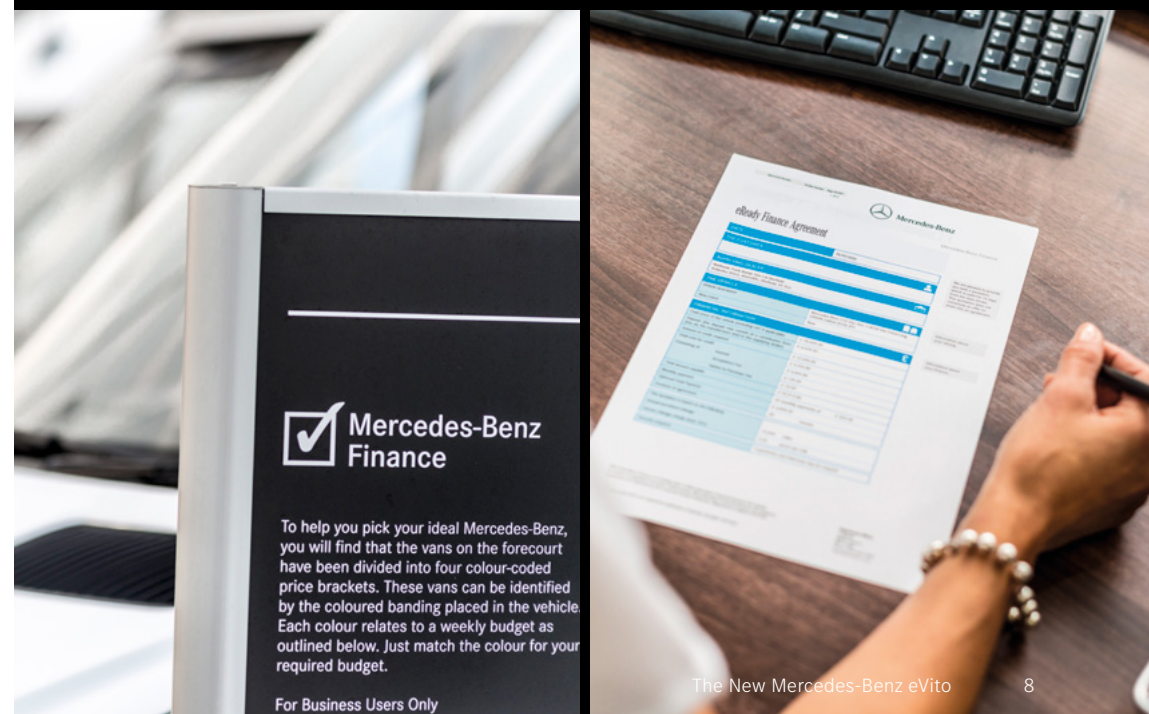

The New Mercedes-Benz eVito

8

New eVito summary

New eVito PROGRESSIVE

New eVito PREMIUM

List prices

eReady finance

Driver Assistance Package

Equipment

Charging information

Technical data

EQ Ready app

Approved used

Service 24h

Driver Assistance Package.



RETURN TO START

Increases active safety and driver comfort to keep you and your drivers even safer on the road.

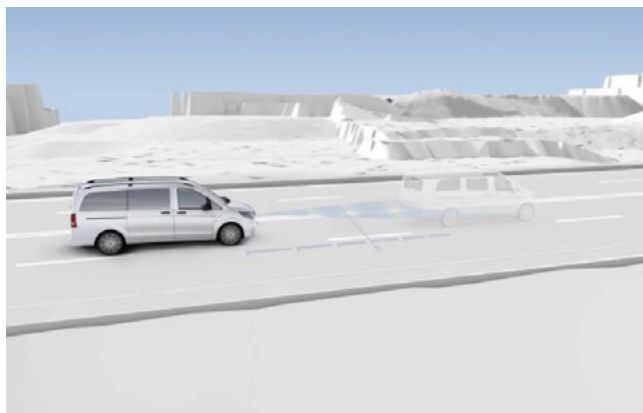

Active Distance Assist DISTRONIC.



Lane Keeping Assist and rain sensor.



Blind Spot Assist with rear cross-traffic alert.

For a safe, more relaxed driving experience: The Driving Assistance Package is an intelligent combination of four assistance systems which take the strain off you while driving and make driving safer. They help you to, amongst other things, maintain a set distance from the vehicle in front, be aware of vehicles in your blind spot and avoid inadvertently straying out of lane. The radar-based Active Distance Assist DISTRONIC automatically maintains the distance from vehicles driving in front, taking the strain off you on motorways or in stop-and-go traffic.

Designed and priced as a package, available for PROGRESSIVE and PREMIUM models.

£1,640.00 ex. VAT

Option package requires leather steering wheel (CL3) for PROGRESSIVE models. Changes to individual option availability and combinations may occur depending on vehicle specification choices and the continuing evolution and adaptation of our product range. These changes may not be immediately reflected in this document as they occur, but will be introduced at the next revision opportunity.



The New Mercedes-Benz eVito

9

New eVito
summary

New eVito
PROGRESSIVE

New eVito
PREMIUM

List prices

eReady finance

Driver Assistance
Package

Equipment

Charging
information

Technical
data

EQ Ready app

Approved used

Service 24h

Equipment (standard and optional overview).



RETURN TO START

Every eVito model comes with a host of standard features, plus a range of optional equipment and packages you can add to enhance your van.

Key: ● Standard ○ Optional ◇ Equipment dependant option available — Not available

Category	Option Description	Option code	PROGRESSIVE	PREMIUM	Basic Price exc. VAT	Basic Price inc. VAT
Audio Entertainment and Navigation	Audio 30 7.8 cm (7 inch) touchscreen DAB+ radio includes Smartphone Integration via Apple® CarPlay and Android Auto and also the Bluetooth® interface with audio streaming and hands-free function for making phone calls while driving with minimal distraction. Includes 2 USB ports.	E3C	●	●	£0.00	£0.00
	Audio 40 7.8 cm (7 inch) touchscreen DAB+ radio with integrated Navigation. Includes Smartphone Integration via Apple® CarPlay and Android Auto and Bluetooth® interface with audio streaming and hands-free function for making phone calls while driving with minimal distraction. Includes 2 USB ports.	EA4	○	○	£400.00	£480.00
Driver Assistance	Active Distance Assist DISTRONIC Automatically maintains the distance to vehicles in front. The system accelerates the vehicle by itself and brakes it with a maximum of half the vehicle's braking power in order to maintain a safe distance.	ET4	○	○	£830.00	£996.00
Paint	Metallic paint	n/a	○	●	£585.00	£702.00
Heating and Ventilation	Heated dual co-driver's seat	H15	○	○	£210.00	£252.00
	TEMPMATIC air conditioning Cools and dehumidifies the air. Features a particulate filter to remove particles of dust and pollen from the outside air.	HH9	●	●	£0.00	£0.00
	THERMOTRONIC automatic climate control Automatically controls temperature, airflow and air distribution in 2 separate climate zones. If outside temperatures are very low, the residual heat mode (REST) can make use of the heat stored in the coolant circuit for up to 30mins after the motor has been switched off.	HH4	○	○	£695.00	£834.00
Intelligent Light System (ILS)	LED Intelligent Light System Automatically adapts light intensity appropriately to weather, lighting and speed. Integrated High Beam Assist automatically adjusts the high and low beam to the traffic situation. The cornering function automatically pivots the projection-type LED headlamps and illuminates static LED cornering lights into upcoming bends to ensure maximum visibility. Includes LED indicators and tail-lights at rear in conjunction with Tailgate (W65). Please check for rear-LED light availability.	LG2	○	○	£1,565.00	£1,878.00
Vehicle Lighting	Halogen front fog lights for vehicles with halogen headlights only	L16	○	●	£205.00	£246.00
	Interior ambient lighting	LP1	○	○	£230.00	£276.00
	LED lightstrip in load compartment	LC2	○	○	£100.00	£120.00
Parking assistance	PARKTRONIC parking sensors, front and rear	EZ8	○	●	£745.00	£894.00

Changes to individual option availability and combinations may occur depending on vehicle specification choices and the continuing evolution and adaptation of our product range. These changes may not be immediately reflected in this document as they occur, but will be introduced at the next revision opportunity.

Equipment (standard and optional overview).



RETURN TO START

Category	Option Description	Option code	PROGRESSIVE	PREMIUM	Basic Price exc. VAT	Basic Price inc. VAT
PRE-SAFE	PRE-SAFE® The PRE-SAFE® anticipatory occupant protection system can detect critical driving situations at an early stage and initiate preventive protection measures.	JP1	○	○	£335.00	£402.00
Airbags	Driver thorax-pelvis sidebag	SH1	○	○	£205.00	£246.00
	Co-driver thorax-pelvis sidebag	SH2	○	○	£205.00	£246.00
	Window airbags for driver and co-driver	SH9	○	○	£440.00	£528.00
Speed limiter	Road speed limiter 80km/h (50mph)	MK5	○	○	No cost option	No cost option
Connectivity	URBAN GUARD vehicle protection The URBAN GUARD vehicle protection function combines a number of security features that improve protection both for your vehicle and any valuables in the interior. It gives both an audible and a visible warning signal if it detects a break-in or theft. Requires a Mercedes me account. Only available for private customers (as of December 2021).	Z2U	○	○	£470.00	£564.00
Tyres	Spare wheel with Jack	RR6	○	○	No cost option	No cost option
	All-season tyres Compared to summer tyres, all-season tyres excel with better traction in wintry road conditions.	RM0	○	○	£160.00	£192.00
	Mud and slush tyres The M+S tyres can improve traction and lateral support in wintry road conditions, improving driving safety on snow, ice and mud.	RM1	○	○	£150.00	£180.00
Flooring	Velour floor mats The black velour floor mats visually enhance the cockpit.	VL2	○	○	£50.00	£60.00
Keys	Two additional master keys	FZ9	○	○	£110.00	£132.00
Seating	Comfort driver's seat Single armrest on the side facing the front passenger; fore/aft adjustment (225mm in total, with 4.5mm intervals); stepless adjustment of the seat backrest angle; stepless seat height adjustment; comfort head restraint adjustable for angle and height.	SB1	●	●	£0.00	£0.00
	Comfort co-driver's seat Comfort driver and co-driver seat with inboard armrests and 4-way adjustable headrests. This deletes the double co-driver seat and therefore limits the cab area to two occupants.	SB2	○	○	£90.00	£108.00
	Black man-made-leather seat upholstery The black man-made leather lends the interior a comfortable aspect and impresses with its low-maintenance and high-comfort surface.	VU9	○	○	£65.00	£78.00
Steering	Leather steering wheel	CL3	○	○	£205.00	£246.00

● Standard ○ Optional ◇ Equipment dependant option available — Not available

Changes to individual option availability and combinations may occur depending on vehicle specification choices and the continuing evolution and adaptation of our product range. These changes may not be immediately reflected in this document as they occur, but will be introduced at the next revision opportunity.

Equipment (standard and optional overview).



RETURN TO START

Category	Option Description	Option code	PROGRESSIVE	PREMIUM	Basic Price exc. VAT	Basic Price inc. VAT
Roof options and brightwork	Carrier bars	D15	○	○	£155.00	£186.00
	Roof rails Maximum load of 150kg, when supported by three carrier bars.	D12	○	○	£115.00	£138.00
	Chrome radiator grille Only available in conjunction with painted bumpers (CM2).	FK2	○	●	£395.00	£474.00
	Chrome interior appointments package The Chrome interior package further enhances the look of the driver's and front-passenger area with its trim elements on the dashboard and in the front doors.	FP4	○	○	£130.00	£156.00
Auxiliary equipment	First aid kit	Y10	○	○	£50.00	£60.00
	Fire extinguisher 1kg	YF7	○	○	£125.00	£150.00
	Warning triangle	Y44	○	○	£45.00	£54.00
Rear door	Tailgate	W65	○	○	No-cost option	No-cost option
GVW	Uprated GVW rating 3.2t	XA5	●	●	£0.00	£0.00

Additional options are also available, for vehicles without the dual co-driver's seat (S23), please talk to your Mercedes-Benz Vans Dealer for more information.

● Standard ○ Optional ◇ Equipment dependant option available — Not available

Changes to individual option availability and combinations may occur depending on vehicle specification choices and the continuing evolution and adaptation of our product range. These changes may not be immediately reflected in this document as they occur, but will be introduced at the next revision opportunity.

Colours and upholstery.



RETURN TO START

Solid paints (no-cost options for PROGRESSIVE and PREMIUM models)



Arctic white
(Standard for PROGRESSIVE)



Pebble grey



Jupiter red



Steel blue



Granite green

Metallic paints (standard for PREMIUM models)



Obsidian black



Brilliant silver



Dark graphite grey



Selenite grey



Cavansite blue



Hyacinth red

Interior upholstery

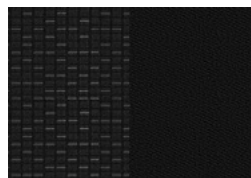

Black Caluma seat
upholstery
(Standard)

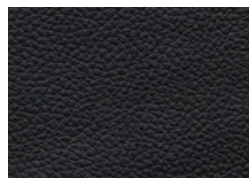

Black leatherette seat
upholstery
(Optional)

Due to limitations of on-screen representation, the vehicle colours may differ in reality to the on screen images.

Charging Information.

Increasing efficiency and reducing downtime.

▶ The eVito can be charged by Direct Current (DC) or Alternating Current (AC).

AC is usually found at homes and workplaces and more cost effective for charging, however, generally requires longer intervals to fully charge. DC power can rapid-charge an electric vehicle using higher charging powers. For example, the eVito can accept 80kW of power.

- AC 7kW: 0-100% in ~6.5 hours†
- AC 11kW 0-100% in ~8 hours†
- DC 80kW 10-80% in just 35 minutes†.

▶ Managing range and battery performance.

The eVito uses a process called recuperation that recovers energy when the vehicle is decelerating to help recharge the vehicle's battery. There are 5 recuperation modes available, which can be adjusted via the steering-wheel paddles. The greater the recuperation level, the faster you decelerate and therefore, the more energy your vehicle will recover. An automatic mode is also fitted as standard, which uses the radar-sensor to intelligently select the best mode for a given driving situation.

- D-** This mode will enable you to get maximum range from your eVito. It has maximum recuperation and fastest deceleration. Due to the deceleration being so strong, your vehicle will automatically activate your brake lights when you lift off the accelerator.
- D** This mode has less recuperation than D- and has similar deceleration levels to a diesel Vito.
- D+/D++** This mode has significantly lower recuperation levels and therefore will decelerate at a slower rate than a diesel Vito. D++ is a coasting mode, meaning your vehicle will have no recuperation and can 'sail' for example when driving for long periods downhill.
- D^{AUTO}** This mode uses the radar-sensor to switch between the best mode for the situation and offers an easy solution for those who want maximum efficiency and highest comfort levels.

† Charging times are subject to the power available at the location where the vehicle will be charged as well as factors such as temperature, charge point and type of cable used.

^ Mercedes-Benz research analysed 1.6 million journeys anonymously on the EQ Ready app and 96% of all journeys recorded were shorter than 100km (62 miles).



Did you know the average van across the UK and Europe travels less than 62 miles[^] a day?



Technical Data - Battery and e-Motor.

System specifications

Fuel	Electricity
e-Motor	3-phase, 6-pole asynchronous induction
Output, peak**	114 hp (85 kW)
Output, long-run**	94 hp (70 kW)
Drive	Front-wheel drive
Battery composition	Lithium-ion
Battery capacity, installed	66 kWh
Battery capacity, usable	60 kWh
System voltage, nominal	400V

Charging specifications

Max. Charging capacity, AC	11 kW
Charging time, AC at 11kW, 0-100%	6 hours 30 minutes†
Max. Charging capacity, DC	80 kW
Charging time, DC at 80kW, 10-80%	35 minutes†
Charging cable supplied with vehicle	Type 2, mode3, 32A, 8m (5kg)

† Charging times are subject to the power available at the location where the vehicle will be charged as well as factors such as temperature, charge point and type of cable used.

**Power available will be reduced in stages by the vehicle when the battery is at ~7% state-of-charge.



RETURN TO START

Technical Data - Euro NCAP Commercial Info.

For its 2021 assessment of Commercial Van Safety, Euro NCAP developed dedicated test and assessment protocols, looking into the Safety Assist Performance of vans.

Safety Assist	Driver	Passenger
Seat belt reminder	●	●
Advanced Driver Assistance Systems		
AEB car-to-car		●
AEB pedestrian		●
AEB cyclist		●
Lane Support Systems		Optional
Speed Assist Systems		●
Attention Assist		●

> Full NCAP Report



The New Mercedes-Benz eVito

15

[RETURN TO START](#)

Technical Data -WLTP Range, CO₂ emissions and Electrical Consumption.

All-electric WLTP Range (mi/km)	CO ₂ emissions, combined, (g/km)	Combined	Low (extra-urban)	Medium (urban)	High (rural)	Extra-high (motorway)
eVito 66kWh Van L2 PROGRESSIVE	0	162/260	199/321	194/313	176/284	130/209
eVito 66kWh Van L3 PROGRESSIVE	0	160/258	197/317	193/310	175/282	129/208
eVito 66kWh Van L2 PREMIUM	0	162/260	199/320	194/312	176/283	130/209
Electrical consumption (kWh/100km)	CO ₂ emissions, combined, (g/km)	Combined	Low (extra-urban)	Medium (urban)	High (rural)	Extra-high (motorway)
eVito 66kWh Van L2 PROGRESSIVE	0	25.7	20.6	21.1	23.4	32.6
eVito 66kWh Van L3 PROGRESSIVE	0	25.9	20.8	21.3	23.5	32.7
eVito 66kWh Van L2 PREMIUM	0	25.8	20.6	21.2	23.4	32.6

The indicated values were determined according to the prescribed measurement method – Worldwide Harmonised Light Vehicle Test Procedure (WLTP). Battery Electric Vehicles (BEV) require mains electricity for charging, range figures determined with the battery fully charged. Figures shown are for comparability purposes; only compare with other cars tested to the same technical procedure (WLTP). Figures may not reflect real life driving results, which will depend upon a number of factors including the starting charge of the battery, factory-fitted options, accessories fitted (post registration), variations in weather, driving styles and vehicle load. Further information about the test used to establish range, power consumption and CO₂ figures can be found at <http://www.mercedes-benz.co.uk/WLTP>. For real time data visit https://voc.mercedes-benz.com/voc/gb_en.

Technical Data - Payload and Weights.

All-electric WLTP Range (mi/km)	Gross vehicle weight, kg	Kerb weight, with driver (75kg), kg	Payload, with driver(75kg), kg	Payload, excluding driver (75kg), kg	Gross Train Weight(GTW), kg	Towing capacity, braked/unbraked, kg
eVito 66kWh Van L2 PROGRESSIVE	3200	2393	807	882	3200	0/0
eVito 66kWh Van L3 PROGRESSIVE	3200	2428	772	847	3200	0/0
eVito 66kWh Van L2 PREMIUM	3200	2451	749	824	3200	0/0

All weights and dimensions quoted are subject to normal manufacturing tolerances of +/- 5%. Stated weight figures in accordance with Directive 97/27/EC in the applicable version at the time of going to print. Stated weight figures are for UK supplied vehicles and include charging cable and all standard equipment. The figures are not based on an individual vehicle and do not constitute part of the product offer; they are provided solely for the purposes of comparison between different vehicle models. The payload figures depend on the optional equipment fitted to the vehicle, please contact your Mercedes-Benz Retail Partner for an individual vehicle calculation. Payload figures include the standard mode3 charging cable (5kg).

Dimensions.



RETURN TO START

Panel Van - PROGRESSIVE/PREMIUM L2

Wheelbase	Wheelbase length	3,200mm
	Turning circle	11.8m
	Track circle	11m
	Front track width	1,666mm
	Rear track width	1,646mm
Vehicle	Length	5,140mm
	Height (unladen)	1,910mm
	Width (inc. wing mirrors)	2,249mm
	Ground clearance	116mm
Load compartment	Length	2,831mm*
	Load volume	6.0m ³
	Max. width	1,685mm
	Width between wheel arches	1,270mm
	Height	1,391mm
	Rear loading height (step height from ground to load floor)	558mm

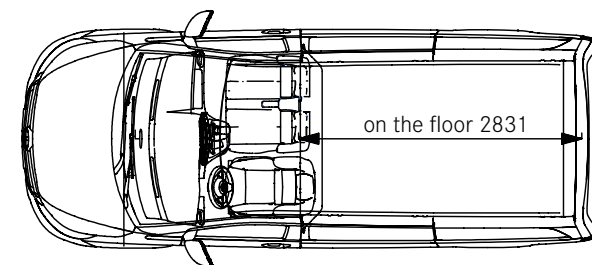
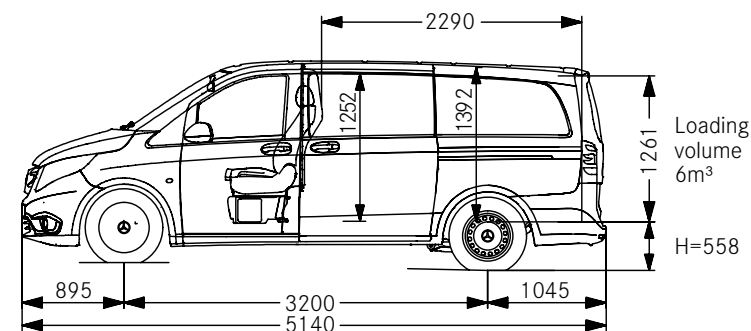
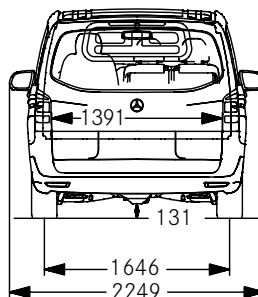
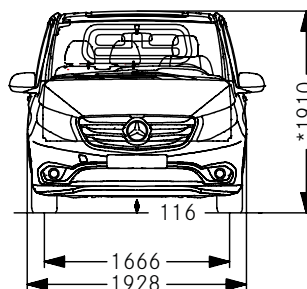

H ca. / *558 *unloaded
Turning circle Ø ca. 11.8m
Track circle Ø ca. 11m

*Measured on vehicle floor and includes 370mm for the space beneath the front seats.

Dimensions.



RETURN TO START

Panel Van - PROGRESSIVE L3

Wheelbase	Wheelbase length	3,430mm
	Turning circle	12.5m
	Track circle	12m
	Front track width	1,666mm
	Rear track width	1,646mm
Vehicle	Length	5,370mm
	Height (unladen)	1,910mm
	Width (inc. wing mirrors)	2,249mm
	Ground clearance	116mm
Load compartment	Length	3,061mm*
	Load volume	6.6m ³
	Max. width	1,685mm
	Width between wheel arches	1,270mm
	Height	1,391mm
	Rear loading height (step height from ground to load floor)	558mm

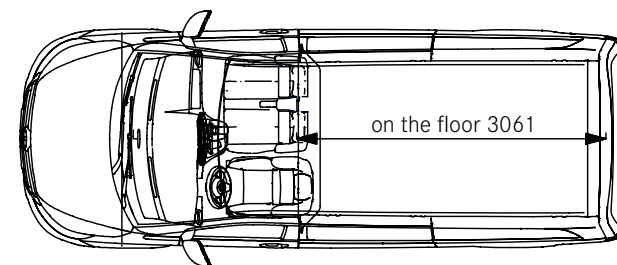
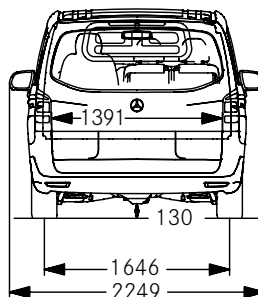
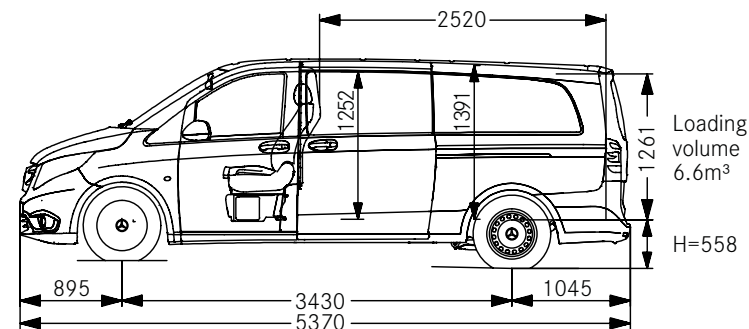
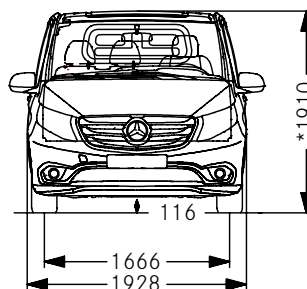

H ca. / *558 *unloaded
Turning circle Ø ca. 12.5m
Track circle Ø ca. 12m

PREMIUM models are not available in L3 configuration.

*Measured on vehicle floor and includes 370mm for the space beneath the front seats.

Mercedes-Benz Electric Vans and the Environment.



RETURN TO START

A key advantage of any battery electric vehicle (BEV) is its positive environmental impact, compared to an internal combustion (ICE) vehicle. Mercedes-Benz electric vans produce no tailpipe emissions.

See right for the Energy Efficiency Rating and emission standards compliance.

Environmental data, Mercedes-Benz electric vans

CO₂ is the main greenhouse gas responsible for climate change.

0	A	Rating: A 0g/km
1-50	A	
51-75	B	
76-90	C	
91-100	D	
101-110	E	
111-130	F	
131-150	H	
151-170	I	
171-190	J	
191-225	K	
226-255	L	
256+	M	

ULEV ✓
Ultra Low Emission Vehicle **ULEV**

ZEV ✓
Zero Tailpipe Emissions Vehicle **ZEV**

ULEZ ✓
Clean Air Zones
(England and Wales) **CAZ**

ULEZ ✓
Ultra Low Emission Zone
(London) **ULEZ**

This vehicle(s) meets the emissions standard for private vans set by government under the Clean Air Zone (CAZ) framework for England and Wales currently in place until 2025. Stricter CAZ standards and restrictions could then apply. Some local authorities may also impose more stringent controls in certain areas. A ULEV meets the current government standard for an Ultra Low Emission Vehicle, stricter standards could apply in the future. See more about future CAZs [here](#).

Ambition 2039

An emission-free fleet of vehicles: With this vision, we are committed to climate protection and air pollution control. That is a core element of our sustainable business strategy. Our ambition is to be CO₂-neutral by 2039. Well ahead of the Paris Climate Accord 2050 deadline.

By 2022, Mercedes-Benz will have battery electric vehicles (BEV) in all segments the company serves. From 2025 onwards, all newly launched vehicle architectures will be electric-only and customers will be able to choose an all-electric alternative for every model the company makes.

As early as 2022, our own Mercedes-Benz car and van plants worldwide will be producing CO₂-neutral vehicles. This applies to more than 30 car and van plants. An important part is the battery production, which will also be CO₂-neutral worldwide as of 2022.



The New Mercedes-Benz eVito

The EQ Ready App.

Are you #eReady?

We know that not every business is ready to go electric – but if you want to find out whether it's right for you, the EQ Ready app is here to help. Take a free virtual test drive and analyse your electric driving potential using your current van, with no obligation and no pressure to make the switch.

- Easily simulate electric driving in your current van.
- Analyse your driving distances and behaviours to get a clear picture of your virtual range and the battery capacity you'd need.
- See public charging stations in your area and add private charging points (such as those owned by your employer or family/friends).
- Test your hypothetical battery's consumption at different temperature scenarios, and experiment with load weights for a realistic and detailed assessment.
- Get set up in seconds by downloading the app on Apple or Android now.



Need further help?

When switching to a brand-new way of keeping your business moving, it's only natural you'll have questions. So, if there's anything you'd like to find out that's not covered in this brochure, then feel free to take a look at:

▶ [The Mercedes-Benz electric van guide](#)

or if you'd preferred to talk to a Dealer, find the nearest one to you:

▶ [Find your preferred Dealer](#)

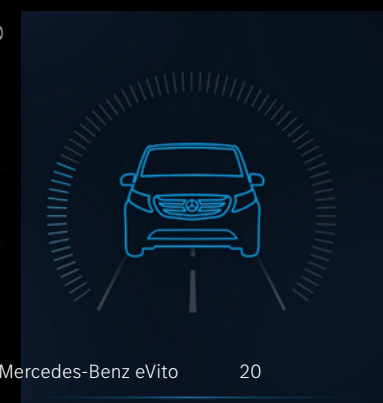
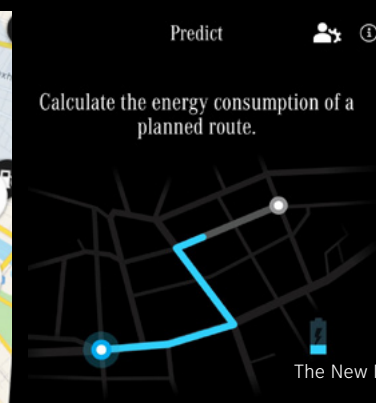
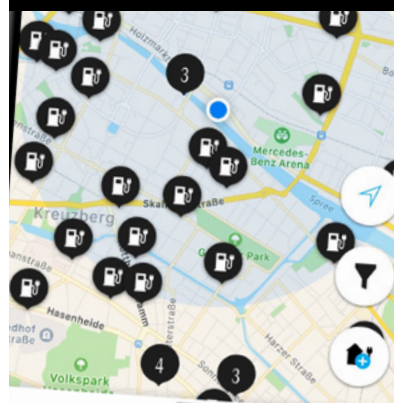

Mercedes-Benz Approved Used Electric vans. Get used to more...

More choice. More confidence. More quality – and more added extras.

As a Mercedes-Benz Approved Used Electric customer, you'll have complete peace of mind as every van offers the same commitment to quality and workmanship as new and comes with:



Minimum 12-month warranty*
PLUS the option of monthly
top-ups, up to 24 months*



Free MOT test failure cover**
covering you for £1,500

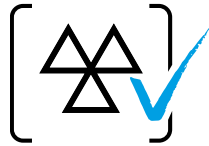

Minimum
3 months MOT

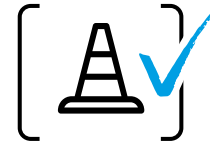

Free 24/7 breakdown cover
and roadside assistance^



Free 7-day driveway
van insurance^^



Comprehensive
multi-point vehicle check



Discounted
service plans

*Warranty eligible up to 200,000 miles on approved used Mercedes-Benz Vans with less than 150,000 miles at point of sale. Top ups are to a maximum of 24 months. For full T&Cs, please speak to your preferred sales representative. ** MOT cover redeemable per 12-months warranty. £1,500 claims limit. For more information, please speak to your preferred sales representative. ^ Free for 12 months initially and renewed at each service, if serviced by MB according to service intervals for up to 30 years from when the vehicle was first registered. For a full list of exclusions and all product terms please visit mbvans.co.uk/mobilovan ^^ Available on single vehicle policies only and applicable on Vehicles up to 3.5t only. For full terms and conditions, please consult your local Dealer. Mercedes-Benz Van Insurance is a trading name of Mercedes-Benz Insurance Services UK Limited. Prices are correct at time of going to press 07/2021. All prices are subject to any fiscal or legislative changes.



Approved
Used
Electric



What is an Approved Used van?

- Is no older than 6 years old
- Has less than 150,000 miles on the clock
- Is eligible for one of our flexible finance plans

➤ [Find more information and our latest Approved Used Electric offers](#)

What is an Approved Used Electric van?

➤ [Visit our Dealer Networks Approved Used Electric van stock](#)

The New Mercedes-Benz eVito

21

Service24: Demand more

The most comprehensive Aftercare package – for businesses that demand more.

Our 120-strong Dealer network works around the clock to service and maintain your vans and keep your business moving. It all adds up to more value, more flexibility and more confidence that you'll only find at an authorised Mercedes-Benz Dealer.



› Flexible servicing and maintenance

Book your service online or by telephone, and as well as a standard 'drop and go' service with a courtesy van, you'll also get:

- Early bird, late night and weekend slots
- Mobile service
- Overnight service
- Collect & deliver service
- Express 1hr service
- Electric van service.

[Find out more about service and repairs](#)



› Flexible ways to pay and save

With fixed, transparent national pricing there are no surprises with our services and repairs – plus you can fix, spread and reduce your service and maintenance costs, and ease your cashflow at the same time, with a payment plan.

- Pay as You Go
- ServiceCare Maintenance
- ServiceCare Flex (specifically for fleets)
- ServiceCare Complete.

[Find out more about service options](#)



› 3-year unlimited mileage warranty

Available on every new van, all service and maintenance – and any work required – is covered by your 3-year unlimited mileage warranty, and is only undertaken by Mercedes-Benz trained technicians using Mercedes-Benz GenuineParts.

› 8 year/160,000km battery certificate

For peace of mind and reliable performance, the eVito's battery comes with an impressive 8 year/160,000km battery guarantee.

[Find out more about warranties](#)



› Free breakdown cover & roadside assistance*

Every van comes with free Europe-wide breakdown cover – MobiloVan. And with 3 years' cover on new vehicles for driver mishaps, no one goes further to keep your business moving.

- Trained technicians using only Mercedes-Benz GenuineParts
- Out of charge cover for electric vehicles
- Forward travel of load and crew is covered
- Driver mishap cover for the first 3 years, including out of charge cover or empty fuel tanks.

[Find out more about MobiloVan](#)

*For a full list of exclusions and all product terms please visit www.mercedes-benz.co.uk/vans/en/Owners/MobiloVan

The Mercedes-Benz eVito

22

